



Installation Manual

Battery Module

M4856-P



V01

IMPRINT

Germany

Alpha ESS Europe GmbH

Tel.: +49 (0)6103 459 160-1

E-mail: europe@alpha-ess.de

Web: www.alpha-ess.de

Add: Paul-Ehrlich-Straße 1a

63225 Langen

China

Alpha ESS Co., Ltd.

Tel.: +86 (0)513 806 868 91

E-mail: info@alpha-ess.com

Web: www.alpha-ess.com

Add: JiuHua Road 888, High-Tech Industrial Development Zone

226300 Nantong City, Jiangsu Province

Australia

Alpha ESS Australia Pty. Ltd.

Tel.: +61 1300 968 933

E-mail: australia@alpha-ess.com

Web: www.alpha-ess.com.au

Add: Suite 1, Level 1, 530 Botany Road, Alexandria, NSW, 2015

Copyright Statement

This manual is under the copyright of Alpha ESS Co., Ltd, with all rights reserved. Please keep the manual properly and operate in strict accordance with all safety and operating instructions in this manual. Please do not operate the system without reading through the manual.

Version Information

Version	Date	Content
V01	Dec. 28 th , 2018	First edition

Content

IMPRINT	1
Copyright Statement.....	2
Version Information	2
Content	3
1. Introduction.....	5
1.1 Features.....	5
1.2 Specifications	5
1.3 Safety Introduction	5
1.3.1. Manual keeping.....	5
1.3.2. Operator Requirements	5
1.3.3. Protection of Warning Sign	6
1.3.4. Setting of Warning Sign for Safety.....	7
1.3.5. Measuring Equipment	7
1.3.6. Moisture Protection	7
1.3.7. Operation After Power Failure	7
1.3.8. Battery Safety Datasheet.....	7
1.4 General Precautions.....	8
1.5 Parts List	10
1.6 Liability Limitation.....	10
2. Installation.....	11
2.1 Installation Site and Environment.....	11
2.1.1. General	11
2.1.2. Restricted Locations	12
2.1.3. Barrier to habitable rooms	12
2.2 Installation.....	13
3. Switch On/Off and Display.....	20
3.1 Switch On/Off	20
3.2 LED Display.....	20

4. Error and Protection Code	21
4.1 Protection Code	21
4.2 Error Code	22
5. Emergency Situations	23
6. Warranty	24
6.1 Warranty	24
6.2 Limitation of Liability	24
7. Routine Maintenance	25
7.1 Maintenance Plan	25
7.1.1. Operating Environment.....	25
7.1.2. Equipment Cleaning.....	25
7.1.3. Cable, Terminal and Equipment Inspection.....	25
7.2 Notes	25
8. Annex	27
8.1 Datasheet	27

1. Introduction

1.1 Features

The M4856-P battery pack has the following features:

Photovoltaic system: This battery pack is designed for household photovoltaic systems.

Battery management system (BMS): The battery packs built-in BMS monitors its operation and prevents the battery from operating outside design limitations.

Expandability: This battery pack can be easily expanded by adding expansion battery packs.

1.2 Specifications

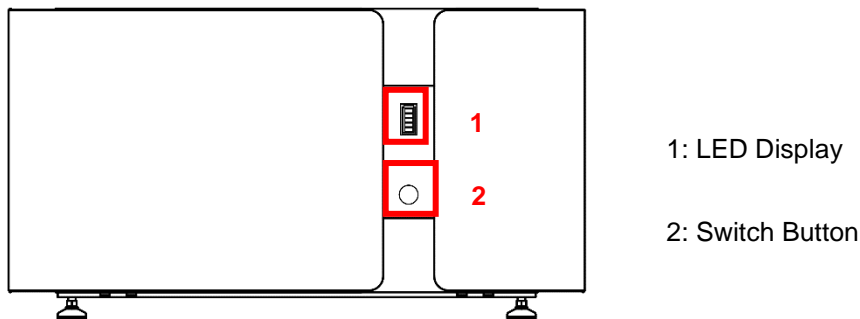

Figure 1 M4856-P Appearance

1.3 Safety Introduction

1.3.1. Manual keeping

This manual contains important information about operating the system. Before operating, please read it very carefully.

The system should be operated in strict accordance with the description in the manual, in case that it causes damages or loss to equipment, personnel and property.

This manual should be kept carefully for maintenance and repairation.

1.3.2. Operator Requirements

The operators should get a professional qualification, or trained.

The operators should be familiar with the whole storage system, including compositions and working principles of the system.









The operators should be familiar with the Product Instruction.

While maintaining, the maintainer is not allowed to operate any equipment until all the equipment has been turned off and fully discharged.

1.3.3. Protection of Warning Sign

The warning sign contains important information for the system to operate safely, and it is strictly prohibited to be torn or damaged. Ensure that the warning sign is always clear. The signs should be replaced immediately when damaged.



	It indicates a hazardous situation which, if not avoided, could result in death or serious injury!
	Danger of high voltage and electric shock!
	Do not puncture, impact, mutilate this unit or put it into the fire. It can lead to explosion.
	Please wash your hands after using the battery.
	Warning: hazards due to batteries.
	The installation and maintenance work should be handled with professional person/s, who is/are knowledgeable about batteries.
	Installation and maintenance reference to this installation and maintenance manual.
	Do not expose to sparks or flame
	Keep out of reach of children



The product must not be disposed of in household waste;



Dispose of it through environmentally friendly collection centres.

1.3.4. Setting of Warning Sign for Safety

While instructing, maintaining and repairing, in case of preventing unrelated personnel nearby to cause incorrect operation or accident, the opinions below should be followed:

- Obvious signs should be set at front switch and rear-level switch in case of accidents caused by false switching.
- Warning signs or tapes should be set near operating areas.
- The system must be reinstalled after maintenance or operation.

1.3.5. Measuring Equipment

For ensuring the electrical parameters to match requirements, related measuring equipment are required when the system is being connected or tested.

Ensure that the connection and use matches specification in case of electric arc or shock.

1.3.6. Moisture Protection

It is very likely that moisture may cause damages to the system.

Repair or maintaining activities in wet weather should be avoided or limited.

1.3.7. Operation After Power Failure

The battery system belongs to energy storage system, and it keeps fatal high voltage even the DC side is disconnected. Therefore, touching the output of the battery is strictly prohibited.

The Inverter maintains fatal voltage even both the DC or AC side are disconnected, so it must be tested by multimeter for safety before operation.

1.3.8. Battery Safety Datasheet

1.3.8.1 Hazard Information

Classification of the hazardous chemical

Lithium Iron Battery is Exempt from classification according to Australian WHS regulations.

Other hazards

This product is a Lithium Iron Phosphate Battery with certified compliance under the UN Recommendations on Transport of Dangerous Goods, Manual of Tests and Criteria, Part III, sub-section 38.3. For the battery cell, chemical materials are stored in a hermetically sealed metal case, designed to withstand temperatures and pressures encountered during normal use. As a result, during normal use, there is no physical danger of ignition or explosion and chemical danger of hazardous materials' leakage. However, if exposed to a fire, added mechanical shocks, decomposed, added electric stress by misuse, the gas release vent will be operated. The battery cell case will be breached at the extreme. Hazardous materials may be released. Moreover, if heated strongly by the surrounding fire, acrid or harmful fume may be emitted.

1.3.8.2 Safety Datasheet

The detailed information please refer to the provided battery safety datasheet, which is provided with the battery product.

1.4 General Precautions



WARNING

Risk of chemical burns from electrolyte or toxic gases.

During standard operation, no electrolyte shall leak from the battery pack and no toxic gases shall form. Despite careful construction, if the Battery Pack is damaged or a fault occurs, it is possible that electrolyte may be leaked or toxic gases formed.

- Do not install the system in any environment of temperature below -10°C or over 50°C and in which humidity is over 85%.
- Do not touch the system with wet hands.
- Do not put any heavy objects on top of the system.
- Do not damage the system with sharp objects.
- Do not install or operate the system in potentially explosive atmospheres or areas of high humidity.
- Do not mount the inverter and the battery pack in areas containing highly flammable materials or gases.
- If moisture has penetrated the system (e.g. due to a damaged enclosure), do not install or operate the system.
- Do not move the system when it is already connected with battery modules.

- Secure the system to prevent tipping with restraining straps in your vehicle.
- The transportation of AlphaESS M4856-P must be made by the manufacturer or an instructed personal. These instructions shall be recorded and repeated.
- A certified ABC fire extinguisher with minimum capacity of 2kg must be carried along when transporting.
- It is totally prohibited to smoke in the vehicle as well as close to the vehicle when loading and unloading.
- For the exchange of a battery module, please request for new hazardous goods packaging if needed, pack it and let it be picked up by the suppliers.
- In case of contact with electrolyte, rinse the affected areas immediately with water and consult a doctor without delay.

**CAUTION:****Risk of injury through lifting or dropping the system.**

The battery is heavy. There is risk of injury if the battery is lifted incorrectly or dropped during transport or when attaching to or removing from the wall.

- Lifting and transporting the inverter and battery must be carried out by more than 1 people.

1.5 Parts List

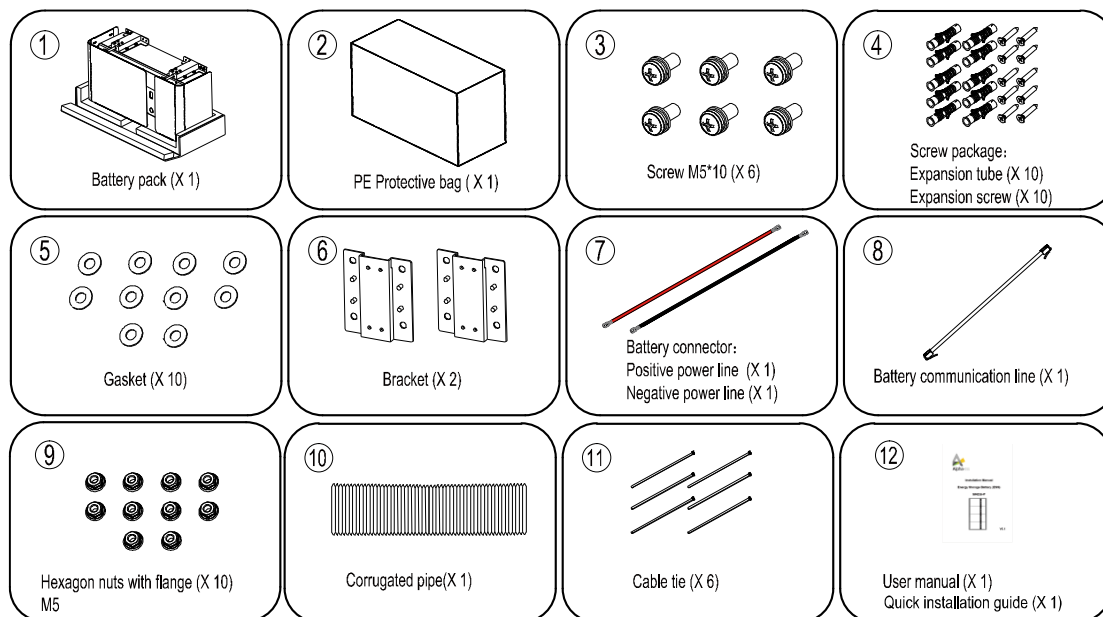

1.6 Liability Limitation

Any product damage or property loss caused by the following conditions AlphaESS does not assume any direct or indirect liability.

- Product modified, design changed or parts replaced without AlphaESS authorization;
- Changes, or attempted repairs and erasing of series number or seals by non AlphaESS technician;
- System design and installation are not in compliance with standards and regulations;
- Failure to comply with the local safety regulations (VDE for DE, SAA for AU);
- Transport damage (including painting scratch caused by rubbing inside packaging during shipping). A claim should be made directly to shipping or insurance company in this case as soon as the container/packaging is unloaded and such damage is identified;
- Failure to follow any/all of the user manual, the installation guide and the maintenance regulations;
- Improper use or misuse of the device;
- Insufficient ventilation of the device;
- The maintenance procedures relating to the product have not been followed to an acceptable standard;
- Force majeure (violent or stormy weather, lightning, overvoltage, fire etc.);
- Damages caused by any external factors.

2. Installation

This Manual introduces the basic steps how to install and operate AlphaESS M4856-P.

M4856-P is a sealed component with no access to battery terminals or cell components within module.

M4856-P contains a Bi-pole DC isolator, which conforms to IEC 60947. It has been operated in all live conductors

ⓘ NOTE: please pay attention for unpacking the battery, the worst case is that some components could be damaged.

2.1 Installation Site and Environment

2.1.1. General

The externals enclosure's material is SPCC. The material thickness is 1.0 mm.

The M4856-P has two versions, one is indoor, and another is outdoor. This M4856-P (indoor version) can only be installed in an indoor location. This M4856-P (outdoor version) can be installed in an outdoor or an indoor location.

Where battery systems are installed within a room, shall be located so that access to the battery is not obstructed by the structure of the building, fixtures and fittings within the room.

M4856-P adopts natural ventilation. The location should be clean, dry and adequately ventilated. The room's entry doors and panels shall open in the direction of egress and allow unobstructed access to the battery for installation and maintenance purposes.

The following location are **not allowed** for installation:

- habitable rooms;
- in ceiling spaces;
- wall cavities;
- on roofs not specifically deemed suitable;
- areas of access/egress;
- under stairways;
- under access walkways;
- sites where the freezing point is reached, like garages, carports or other places;
- sites with humidity and condensation over 85%;
- sites which are salty and where humid air can penetrate;
- earthquake areas –additional security measures are required here;
- sites that are higher than 3000 meters above the sea level;
- sites with explosive atmosphere;

- sites with direct sunlight;
- sites with extreme change of ambient temperature;
- wet rooms;
- sites with highly flammable materials or gases; or
- sites with a potentially explosive atmosphere;

2.1.2. Restricted Locations

The battery system shall **not be** installed —

- (a) in restricted locations, as defined for switchboards in AS/NZS 3000;
- (b) within 600 mm of any hot source, such as water unit, gas heater, air conditioning unit or any other appliance.
- (c) within 600 mm of any exit;
- (d) within 600 mm of any window or ventilation opening;
- (e) within 900 mm of access to 240 Vac connections; and
- (f) within 600 mm of side of other equipment.

A M4856-P installed in any corridor, hallway, lobby or the like leading to a fire exit shall ensure sufficient clearance from the M4856-P for safe egress and no less than 1 m.

A M4856-P is considered a source of ignition and therefore shall not be installed within hazardous area for gas cylinders containing heavier than air gasses and gas relief vent terminal as defined in AS/NZS 3000.

2.1.3. Barrier to habitable rooms

To protect against the spread of fire to habitable rooms, where the M4856-P is mounted on, placed against a surface of a wall or structure that has a habitable room on the other side, the wall or structure shall be a suitably non-combustible barrier. If the mounting surface itself is not made of a suitably non-combustible material, a non-combustible barrier may be placed between the M4856-P and the surface of a wall or structure.

Where the M4856-P is located on or within 300mm of the wall or structure separating it from the habitable room, the barrier shall extend —

- (i) 600 mm beyond the vertical sides of the M4856-P;
- (ii) 1200 mm above the M4856-P; and
- (iii) to the extent of the bottom of the M4856-P.

Where the top of the M4856-P is within 1200 mm of the ceiling or structure above the M4856-P, the ceiling or structure surface shall be suitably non-combustible for an area of 600 mm past the extremities of the M4856-P.

M4856-P shall be mounted with the highest point no greater than 2.2 m above the floor or platform.

2.2 Installation

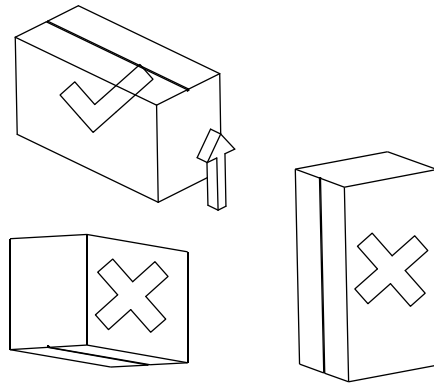

Step 1: open the battery package.

i **Note:** The box must be placed in the direction of the label and only remove the packaging in upwards direction. Removing the packaging in other directions is wrong.

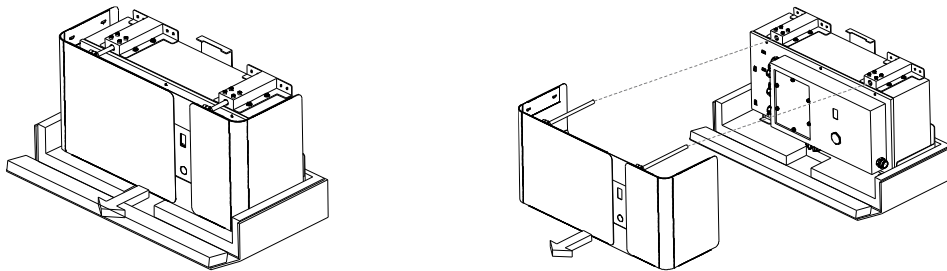

Step 2: Pull off the buckle located in the middle of the bottom.

Pull the top two guide rods to remove the front panel.

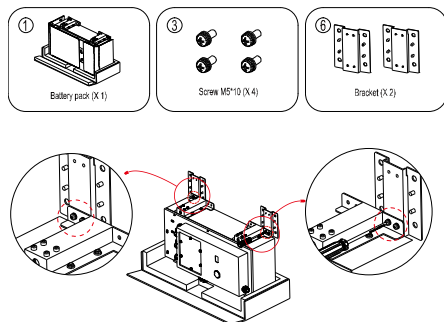

Step 3: Use a screwdriver to assemble the battery mounting brackets onto the battery back panel.

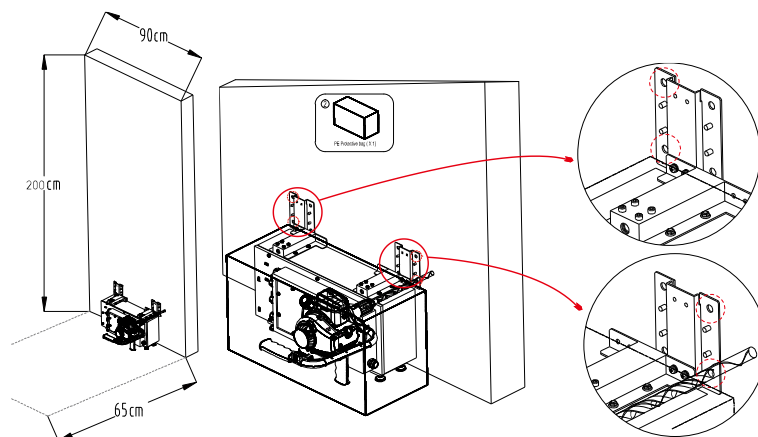

Step 4: Push the battery firmly against the wall and use a level to confirm the position of the battery. Please drill four holes (two on each side) directly on the wall at the marking positions of the brackets with an impact drill (bit ϕ 8.0mm, length 20cm) and the depth of each hole should be about 7 cm.

i Note: 1: Check installation space.

2: Pack the PE bag on the battery to block out the dust before drilling.

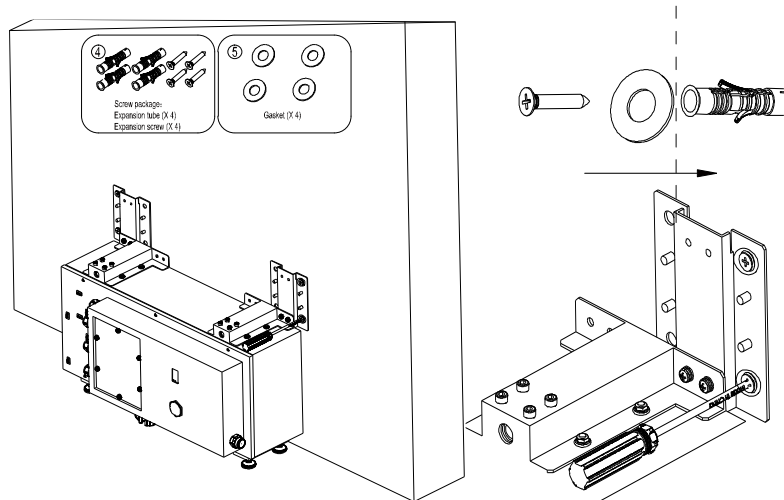

Step 5: Insert the expansion tube into the drilled hole. Pass the expansion screw through the gasket and lock with a screwdriver. M4856-P is stackable with maximum of 4 batteries in one row.



Step 6.1: Battery power cable connection sequence:

Go through the waterproof cap → go through the sealing ring → go through the joint, fixed to the copper bar with M5 nut inside of the battery.

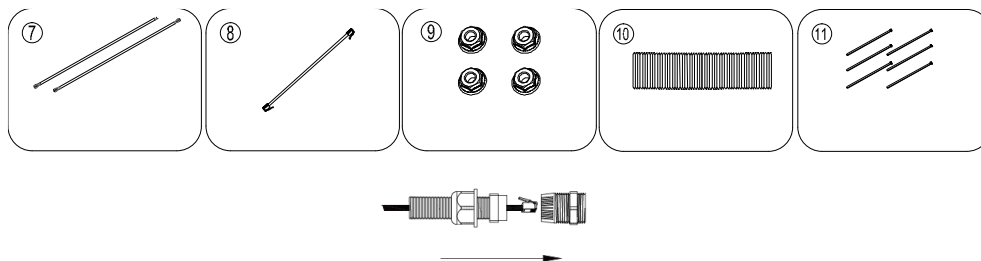

Step 6.2: Battery communication cable connection sequence:

The RJ45 connector of the communication cables shall go through the waterproof cap → go through the sealing ring → go through the joint and be inserted into the COM port inside of the battery.

1. The waterproof connector is rotated counterclockwise according to the installation procedure to remove the plug.
2. Use a screwdriver to remove the maintenance cover before wiring.
3. All air switches are set to disconnect at the factory. Please check before wiring.
4. The waterproof joint seal should be confirmed whether it is inserted into the plastic claw ring during installation.

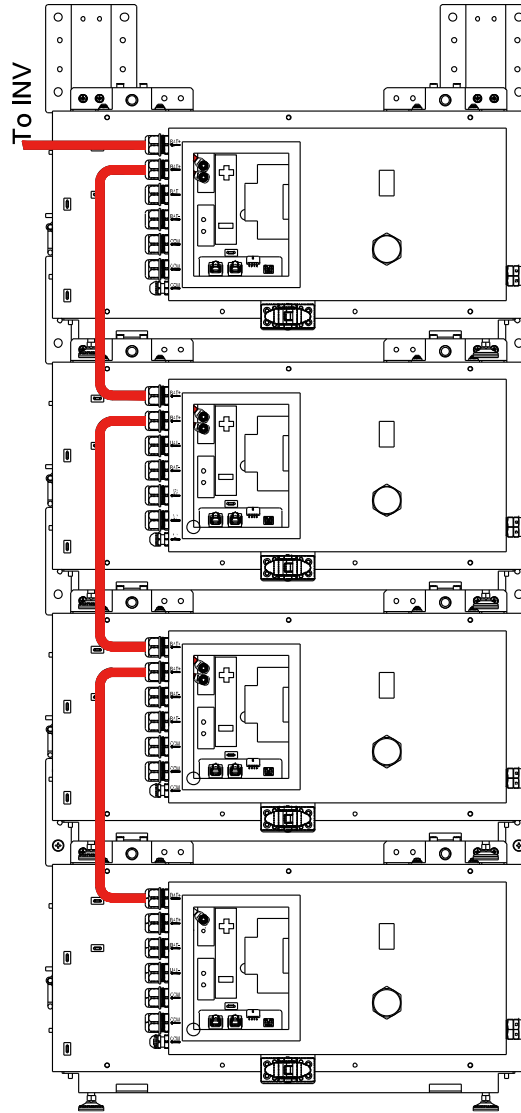

Step 7: Please connect the positive poles one battery to another with red power cables as the above figure shows.

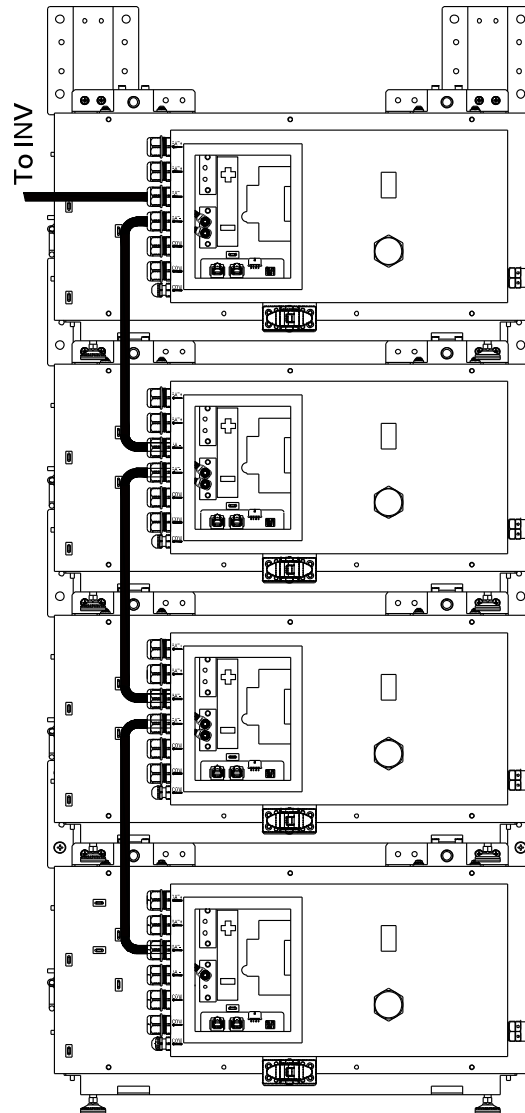

Step 8: Please connect the negative poles one battery to another with black power cables as the above figure shows.

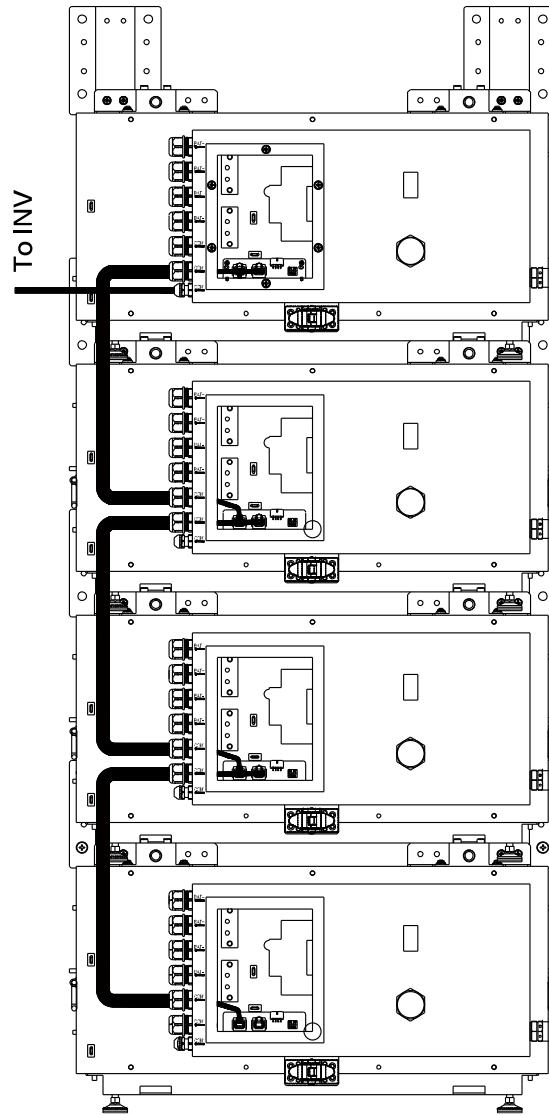

Step 9: Please connect the communication ports one battery to another with the communication cables as the above figure shows.

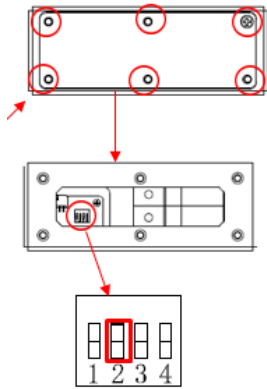

Step 10: Communication board DIP switch configuration:

Confirm that the battery closest to the inverter is number 1 battery and so on. The maximum number of parallel batteries is 6.

The direction of the last DIP switch of the battery is configured according to the black mark position of the No. 6 figure, that is, the last battery dial switch 2 is up and the other battery dial switches are all down.

When the number of batteries is between 2 and 6 sets, the dial switch configuration is operated according to the sequence.

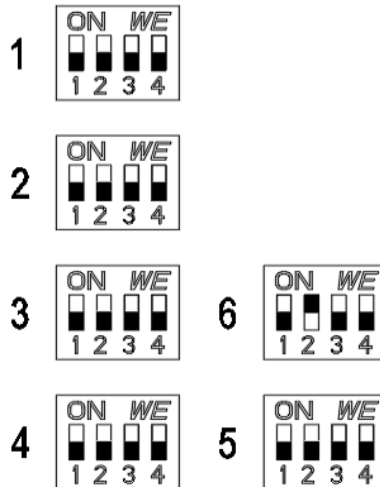

3. Switch On/Off and Display

3.1 Switch On/Off

System shall be turned on in the correct sequence to avoid any damage.

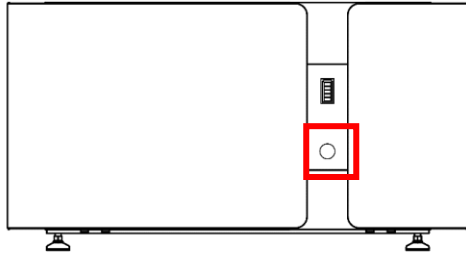

Figure 2 M4856-P Switch

Switch on :

Pressing the power button for about 2-4 seconds. The BMS will start up. The LED display and power button will light up as well.

Switch off :

Pressing the power button for >5 seconds, Turns off battery modules.

NOTE: when the battery is working pressing the power button for <5 seconds, LCD display will light up for 30 seconds.

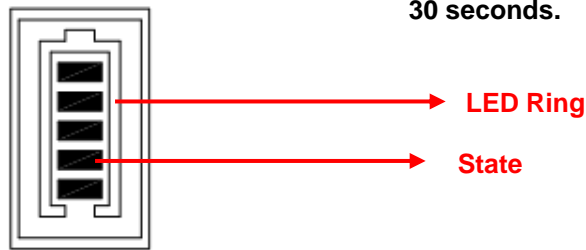







Figure 3 LED Display

3.2 LED Display









In normal condition, LED display indicates the SOC as the figure below:

LED Ring	SOC	Description
Standby: Green light flickering 1 s Work: Green light flickering 10s		SOC<5%
		5%=<SOC<25%
		25%=<SOC<50%









		50%= \leq SOC<75%
		75%= \leq SOC<95%
		SOC>95%

4. Error and Protection Code

4.1 Protection Code

LED Ring	Protection Code	LED Display	Description
Green light flickering every 3 seconds.	1		Temperature difference
	3		High temperature
	4		Low-temperature discharge
	5		Over-current charge
	6		Over-current discharge
	8		Cell overvoltage
	9		Cell under voltage
	11		Low-temperature charge

4.2 Error Code

LED Ring	Error Code	LED display	Description	Troubleshooting
Red light flickering every 3 seconds.	Error 01		Hardware error	Wait for automated recovery. In case problem is not resolved, call in for repair.
	Error 03		Hardware error	
	Error 05		Hardware error	
	Error 06		Circuit Breaker Open	Close circuit breaker after Shutting down the battery system.
	Error 07		DIP difference	Keep consistence of DIP switches, restart the system.
	Error 08		LMU Disconnect (slave)	Reconnect the communication cable
	Error 09		SN missing	Enter the serial number, restart the system or call in for repair.
	Error 10		LMU Disconnect (master)	Reconnect the communication cable
	Error 11		Software version inconsistent	Call installation for repair.

i NOTE:

- If the battery constantly runs for 30 days and its SOC hasn't been corrected, the discharging function will not be allowed until the battery is fully charged for at least once and the SOC is corrected.
- In the case of parallel mode or work mode, if Protection 09 appears and the power button is pressed 5 times within 10 seconds, the BMS will be forced to turn on MOS of

discharge so that the battery voltage can be detected by the inverter and the battery can be charged.

5. Emergency Situations

AlphaESS cannot guarantee M4856-P absolute safety.

Fire

In case of fires, make sure that the following equipment is available near the system.

- SCBA (self-contained breathing apparatus) and protective gear in compliance with the Directive on Personal Protective Equipment 89/686/EEC.
- Novec 1230, FM-200, or dioxide extinguisher.

i **NOTE: ABC extinguishers are not effective when the battery pack is on fire.**

Batteries may explode when heated above 150° C. If possible, move the battery pack to a safe area before it catches fire.

Leaking Batteries

If the battery pack leaks electrolyte, avoid contact with the leaking liquid or gas. If one is exposed to the leaked substance, immediately perform the actions described below:

- **Inhalation:** Evacuate the contaminated area, and seek medical attention.
- **Contact with eyes:** Rinse eyes with flowing water for 5 minutes, and seek medical attention.
- **Contact with skin:** Wash the affected area thoroughly with soap and water, and seek medical attention.
- **Ingestion:** Induce vomiting, and seek medical attention.

Wet Batteries

If the battery pack is wet or submerged in water, do not let people access it, and then contact AlphaESS or an authorized dealer for technical support.

Damaged Battery

Damaged batteries are dangerous and must be handled with the utmost care.

They are not fit for use and may pose a danger to people or property.

If the battery pack seems to be damaged, pack it in its original container, and then return it to AlphaESS or an authorized dealer.

i **NOTE: Damaged batteries may leak electrolyte or produce flammable gas. If such a damage occurs, immediately contact AlphaESS.**

6. Warranty

6.1 Warranty

Products that are operated strictly in accordance with the user manual and the AlphaESS Installation Manual are covered by the warranty. Any violation of this manual may void the warranty.

6.2 Limitation of Liability

Any product damage or property loss caused by the following conditions AlphaESS does not assume any direct or indirect liability.

- Product modified, design changed or parts replaced without AlphaESS authorization;
- Changes, or attempted repairs and erasing of series number or seals by non AlphaESS technician;
- System design and installation are not in compliance with standards and regulations;
- The Product has been improperly stored in dealer's or end user's premises;
- Transport damage (including painting scratch caused by movement inside packaging during shipping). A claim should be made directly to shipping or insurance company as soon as the container/packaging is unloaded and such damage is identified;
- Failure to follow any/all of the user manual, the installation guide and the maintenance regulations;
- Improper use or misuse of the device;
- Insufficient ventilation of the device;
- The maintenance procedures relating to the product have not been followed to an acceptable standard;
- Force majeure (violent or stormy weather, lightning, overvoltage, fire etc.).
- Damages caused by any external factors.

7. Routine Maintenance

7.1 Maintenance Plan

- Check if wire connection loose.
- Check if cables aged/damaged.
- Check if cable insulating ribbon drop.
- Check if cable terminal screw loose, any overheat sign.
- Check if ground connection is well.

7.1.1. Operating Environment

(Every half year)

Carefully observe whether the battery system equipment is ineffective or damaged;
When the system is running, listen to any part of the system for abnormal noise;
Check whether the voltage, temperature and other parameters of the battery and other equipment parameters are normal during system operation;

7.1.2. Equipment Cleaning

(Every six months to one year, depending on the site environment and dust content, etc.)

Ensure that the ground is clean and tidy, keep the maintenance access route unblocked, and ensure that the warning and guiding signs are clear and intact.

Monitor the temperature of the battery module and clean the battery module if necessary.

7.1.3. Cable, Terminal and Equipment Inspection

(Every six months to one year)

- Check if the cable connection is loose.
- Check whether the cable is aging or damaged.
- Check whether the cable tie of the cable has fallen off.
- Check if the cable terminal screws are loose and the terminal position has any signs of overheating.
- Check whether the management system of the system equipment, monitoring system and other related equipment are invalid or damaged.
- Check that the grounding of the equipment is good and the grounding resistance is less than 10 ohms.

7.2 Notes

After the equipment are out of operation, the following notes should be paid attention to while maintaining:

- Related safety standards and specifications should be followed in operation and maintenance.
- Disconnect all the electrical connections so that the equipment would not be powered on.
- Wait at least 5 minutes after disconnection in case that the residual voltage of capacitors down to safe voltage. Use a multimeter to ensure the equipment is completely uncharged.
- The equipment should be repaired by professional staff and it is strictly for-bidden for maintenance staff to open equipment on their own.
- Appropriate protective measures should be taken while maintaining, such as insulated gloves, shoes, and anti-noise ear plugs.
- Life is priceless. Make sure no one would get hurt first.
- The batteries need to be charged to 30%~50%SOC rate when the whole system is static (that is, the batteries has not been charged for two weeks or longer) for a long time, in case of over discharge.

Please contact us in time if there are any conditions that could not be explained in the manual.

8. Annex

8.1 Datasheet

Physical	
Model	M4856-P
Battery Type	LFP (LiFePO4)
Battery Manufacturer	
System Weight	42 kg
Dimension (W x D x H)	610 mm x 236 mm x 303 mm
IP Protection	IP21 (Indoor) / IP65 (outdoor)
Warranty	10 Year Battery Warranty
Electrical	
Energy Capacity	2.9 kWh
Usable Capacity	2.8 kWh
Depth of Discharge (DoD)	96%
Nominal Voltage	51.2 V
Operation Voltage Range	48 V ~ 57.6 V
Internal Resistance	≤ 30 mΩ
Cycle Life	10 000*
Operation	
Max. Charge Current	56 A (1C)
Max. Discharge Current	56 A (1C)
Max. Short-circuit Current	200A
Operating Temperature Range	-10 °C ~ 50 °C**, 0 °C ~ 40 °C (1C)
Humidity	15% ~ 85%
BMS	
Modules Connection	1 ~ 6 in parallel
Capacity Range	2.9 / 5.8 / 8.6 / 11.5 / 14.4 / 17.2 kWh
Usable Capacity Range	2.8 / 5.5 / 8.3 / 11.0 / 13.8 / 16.5 kWh
Power Consumption	<2W (Work), <100mW (Sleep)
Monitoring Parameters	System voltage, current, cell voltage, cell temperature, PCBA temperature measurement
Communication	CAN and RS485 compatible

* Under specific test conditions
 **When the temperature is below 0 °C or above 40 °C, the performance will be limited.

