

WINDSIDE

WS-0,15B dimensions and technical info

Windside WS-0,15B technical info:

- Weight: 38 kg
- Swept area: 0,15 m²
- Generator: 9A in delta, 6A in star connection
- Voltage: 12V battery charging mode 15V
24V battery charging mode 30V
- Fastening of the turbine with 6 pc of M12 bolts
- Wind load, side force to the middle point of the vane,
Calculated 0,25 m up from the generator: 50 kg
- The weight of the base depends on
the height of the mast - in other words
on the length of the torque arm.
- WS-0,15B-model Max 2000 rpm
- WS-0,15B Guaranteed at constant wind speed of 40 m/s

Materials:

- Vanes: fibre glass
- Fastenings: aluminium
- Shaft: Ø25 mm chrome coated steel
- Generator and Generator End Plates: dip galvanized steel
or marine grade aluminium
- All bolts stainless steel or dip galvanized (A4, A2 or Zn)

Assets of Windside wind turbines:

- No need to stop or secure during storms
- Produces max. amount of energy in storms
- No need to be turned to the wind direction
- Soundless; 0 dB, measured in 2 meters distance
from the vane
- Stands snow, frost, heat and humidity
- Long lifespan
- Minimum need of maintenance, only lubrication
- Safe to people, animals and nature

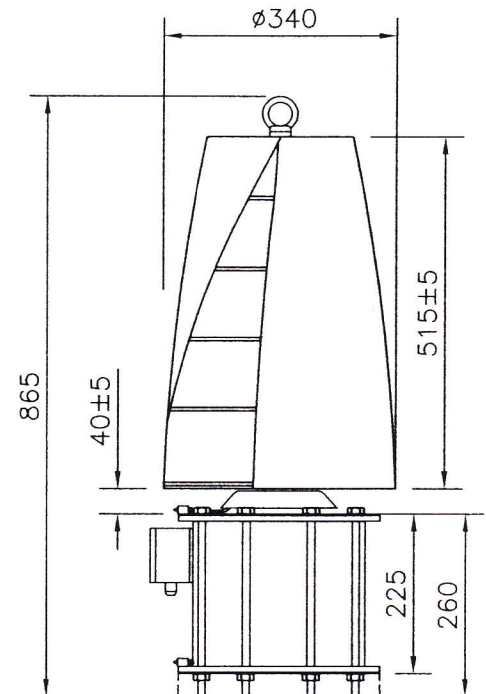
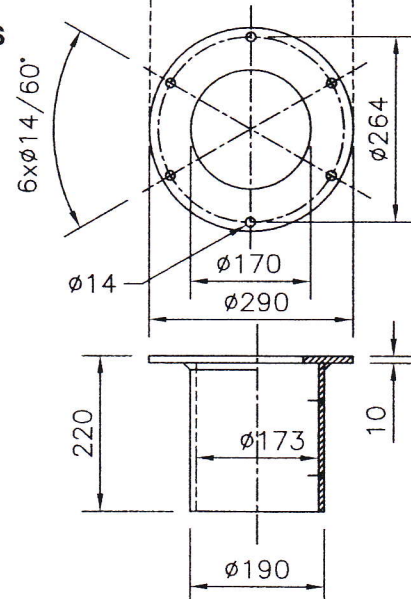
**MOUNTING
DIMENSIONS**

windside

OY WINDSIDE PRODUCTION Ltd

E-mail and internet:
finland@windside.com
www.windside.com

Tel.: +358-208-350 700
Fax: +358-208-350 701
Mobile: +358-400-315 037

The Manufacturer reserves
all rights to all modifications
without further notice.