

Colour your life!

BISOL Spectrum Series



Solar company!





"The client wasn't prepared to have Blue and Silver on the roof next to their beautiful Oast house. When I showed them the Bisol Spectrum range coupled with the 20 year warranty and better energy harvest from the micro inverters, the customer was very interested."

Richard Cromarty, Director JPS Renewable Energy

BISOL Spectrum Series

With respect for our natural surrounding and the architectural legacy in mind, we are introducing an exclusive BISOL Spectrum series of photovoltaic modules with coloured cells, whereby you no longer have to compromise aesthetics for efficiency when harnessing the endless power of the sun.

BISOL spectrum modules were designed not only to conform, but also to refine the architectural traits of buildings and roofs of various types and styles. Available in a wide palette of colours, BISOL Spectrum series PV modules can now really become an integral part of the building in its natural setting, or by contributing in the manifestation of the building's modern design features. Their unique look allows discreet blending with the scenery, hence preserving the timeless beauty of diverse natural settings. Either way, BISOL Spectrum modules will undoubtedly add a timeless aesthetical value.

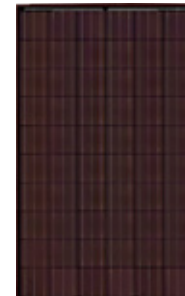











Rustic Red



"And the needles of the pine trees, freshly washed to a deep, rich green, shimmered with droplets that blinked like clear crystals."

Billie Letts

Advantages

-  Made in EU
-  Available in variety of colours
-  A perfect colour match to your roof
-  On-roof or BIPV
-  Strictly positive power output tolerances
-  PID free
-  Module presorting for a more profitable investment
-  Double insulation
-  Extremely low degradation
-  Excellent performance in low light conditions

Warranties:

-  Product warranty 10 years
-  Linear warranty 85% output in 25th year

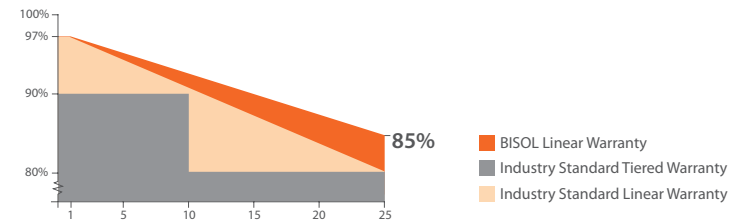

Pine Green

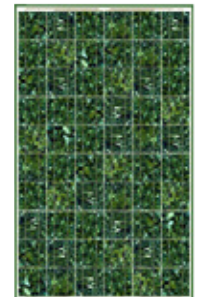

Marble Green



"The sky is already purple; the first few stars have appeared, suddenly, as if someone had thrown a handful of silver across the edge of the world."
 Alice Hoffman

Electrical Specifications @ STC (AM1.5, 1,000 W/m², 25 °C)

Module Type (BMU or BSU)		230	235	240	245	250
Nominal Power	P_{MPP} [W]	230	235	240	245	250
Short Circuit Current	I_{SC} [A]	8.40	8.50	8.55	8.65	8.75
Open Circuit Voltage	V_{OC} [V]	37.3	37.6	37.9	38.1	38.4
MPP Current	I_{MPP} [A]	7.85	7.95	8.03	8.15	8.25
MPP Voltage	V_{MPP} [V]	29.3	29.6	29.9	30.1	30.3
Solar Cell Efficiency	η_c [%]	15.8	16.1	16.4	16.8	17.1
Module Efficiency	η_M [%]	14.1	14.4	14.7	15.0	15.3
Power Output Tolerance		0/+5 W				
Maximum Reverse Current		13 A				
Maximum System Voltage		1,000 V (Application Class A)				

Efficiency at irradiation 200 W/m² decreases to 95.7 % of efficiency at STC.

Electrical Specifications @ NOCT (AM1.5, 800 W/m², Cell Temp. 44 °C)

Module Type (BMU or BSU)		230	235	240	245	250
Nominal Power	P_{MPP} [W]	170	174	177	181	185
Short Circuit Current	I_{SC} [A]	6.80	6.88	6.92	7.00	7.08
Open Circuit Voltage	V_{OC} [V]	34.0	34.3	34.6	34.8	35.1
MPP Current	I_{MPP} [A]	6.36	6.43	6.50	6.57	6.68
MPP Voltage	V_{MPP} [V]	26.7	27.0	27.3	27.6	27.7

I-V Curve

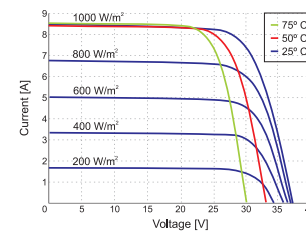

Effective Efficiency

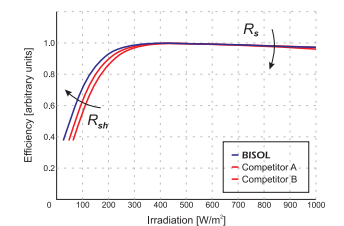

Charming Purple

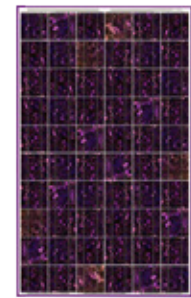

Marble Pink



"Autumn seemed to arrive suddenly that year. The morning of the first September was crisp and golden as an apple..."
J.K. Rowling

Thermal Specifications

Current Temperature Coefficient	α	+ 4.9 mA/°C
Voltage Temperature Coefficient	β	- 121 mV/°C
Power Temperature Coefficient	γ	- 0.35 %/°C
NOCT		44 °C
Temperature range		-40 °C to +85 °C

Mechanical Specifications

Solar Cells	60 multi c-Si in series / 156 mm x 156 mm (6+")
Cell Colour Pattern	Single-shade or multi-shade (Marble)
Junction Box / Connectors	Three bypass diodes / MC4 compatible / IP 67
Frame	Standard frame (anodized AL with drainage holes and rigid anchored corners) or BIPV (Solrif®) frame
Frame Colour	Any RAL colour code, black or silver
Back Sheet Colour	Black, white or transparent
Glass	3.2 mm tempered glass / high-transparency / low-iron content
Impact resistance	Hailstone / Φ 25 mm / 83 km/h (51 mph)

Certificates



*Applicable to BMU 230-250 PV modules with standard frame.



Olive Green

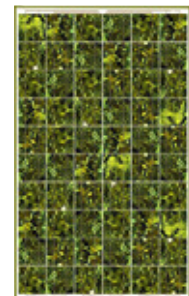



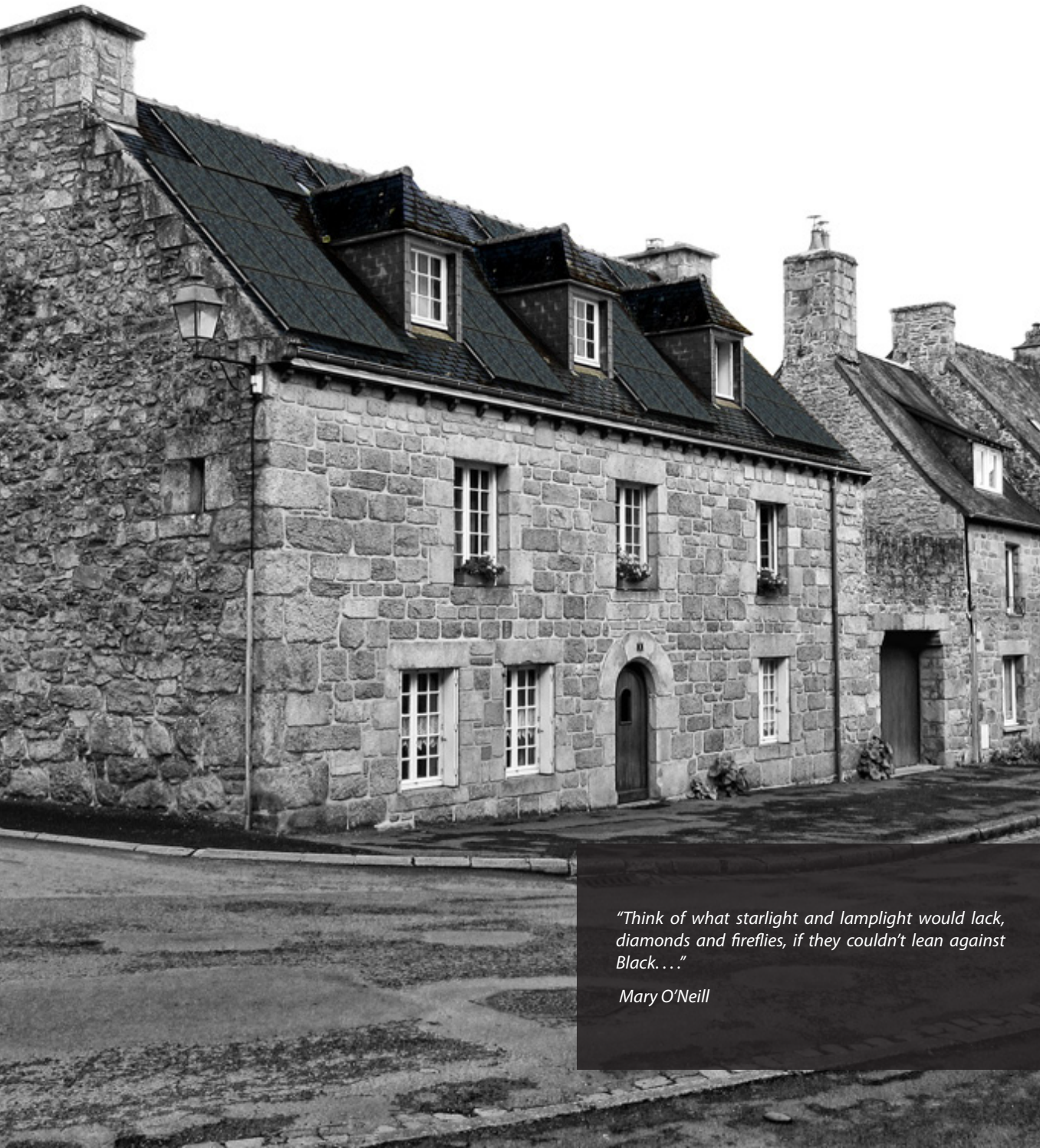





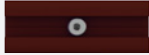



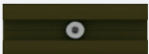

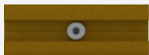
Marble Gold

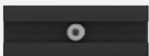

"Think of what starlight and lamplight would lack, diamonds and fireflies, if they couldn't lean against Black..."
 Mary O'Neill

Colour Availability

Solar Cells		Frames, BIPV Flashings, Middle and End Clamps	
	Rustic Red		RAL 8017
	Pine Green		RAL 6009
	Marble Green		RAL 6003
	Olive Green		RAL 1036
	Marble Gold		RAL 7011
	Charcoal Grey		RAL 4007
	Marble Grey		RAL 4004
	Charming Purple		
	Marble Pink		

The actual colour shades may vary from the images shown. Colour inconsistencies of solar cells in a module may appear due to the nature of this product.



Charcoal Grey



Marble Grey



"Happiness is a color that you can never run out of. You can paint a picture or an illusion with happiness. It's a color that you always pick, before actually choosing a color."

Lionel Suggs

On-Roof Solution

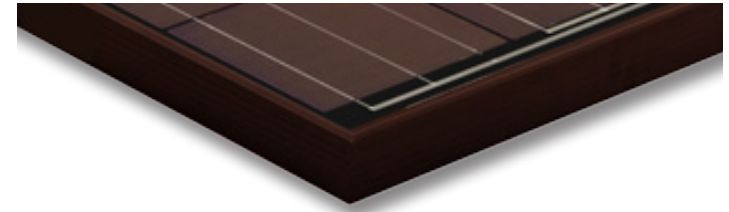

Detail of standard frame

Mechanical Specifications	
Length x Width x Thickness	1,649 mm x 991 mm x 40 mm / (64.92" x 39.02" x 1.575")
Weight	18.5 kg (40.79 lbs)
Frame	Standard frame (anodized AL with drainage holes and rigid anchored corners)
Packaging	16 or 25 modules per pallet / stackable 3 pallets high
Certified Nominal Load	5,400 Pa

Dimensions

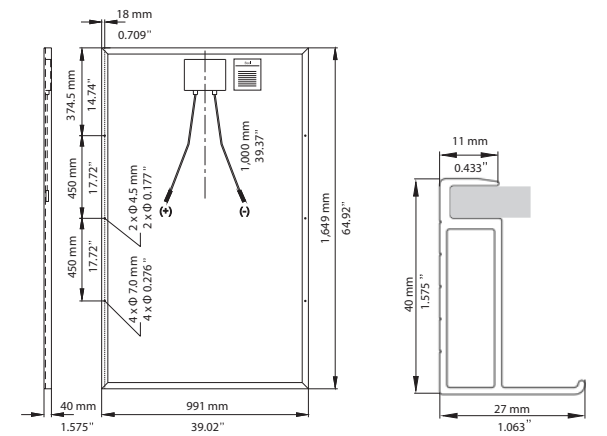

BISOL Spectrum module with standard frame

Cross section of standard frame



Roof-Integrated Solution

BISOL Spectrum PV modules are also available as a BIPV solution used in roof-integrated applications. The overlapping of the specially framed BIPV modules produces an elegant PV array which completely replaces the conventional roofing. Maximum visual conformity and an unobtrusive appearance of the PV system are achieved by fully matching the colour of the end flashings, making it especially appealing to the eye. Coloured PV modules teamed up with building-integrated trim allow the PV system to fully blend in with even the most particular roof types, offering new possibilities of applying photovoltaic to most delicate historic and listed buildings in conservation areas.

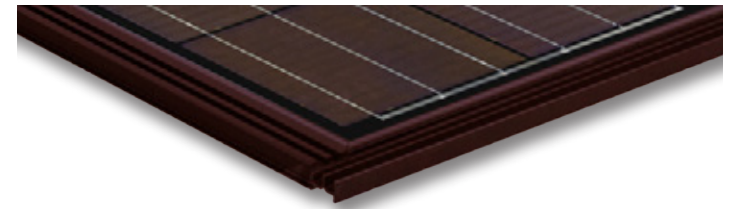

Detail of special BIPV (Solrif®) frame

Mechanical Specifications

Length x Width x Thickness	1,692 mm x 1,016 mm x 29 mm (66.61" x 39.99" x 1.14")
Weight	18.4 kg (40.57 lbs)
Frame	Solrif®
Glass	3.2 mm tempered glass / high-transparency / low-iron content
Packaging	24 modules per pallet / Stackable 2 pallets high
Certified Nominal Load	2,400 Pa

Dimensions

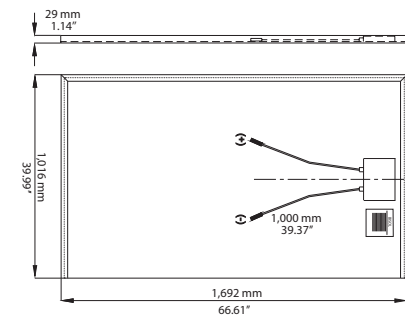

BISOL Spectrum module with BIPV frame

"Mere color, unspoiled by meaning, and unallied with definite form, can speak to the soul in a thousand different ways."

Oscar Wilde





"Thanks to the BISOL Spectrum Series, we now have the possibility to please all our customer concerns. Some of them dislike solar panels because of their aesthetic appearance, while for the majority the return on investment (ROI) is of the highest importance. Now we have the solution that meets both needs – BISOL Spectrum Series!"

Zonnepanelen Volendam, the Netherlands

BISOL Group

Latkova vas 59a
3312 Prebold
SLOVENIA
T: +386 (0)3 703 22 50
F: +386 (0) 3 703 22 63
E: info@bisol.si

BISOL Solar Ltd. UK

Capital Business Centre
Unit 11J, 22 Carlton Road
South Croydon, CR2 0BS
UNITED KINGDOM
T: +44 (0)208 916 2404
F: +44 (0)208 916 2001
E: uk@bisol.com

BISOL France

Savoie-Technolac
48 avenue du Lac du Bourget
Le Square Bât Noroit BP 317
73377 Le Bourget du Lac Cedex
FRANCE
M: +33 (0)6 48 12 65 12
E: info@bisol.fr

BISOL Italy

Via Bonazzi, 5
40013 Castel Maggiore (BO)
ITALY
T: +39 051 705 697
F: +39 051 705 697
E: italia@bisol.com

BISOL Benelux

Wingepark 47
3110 Rotselaar
BELGIUM
T: +32 (0)484 08 80 78
E: info@bisol.com

Dealer information

