

BVM6612M

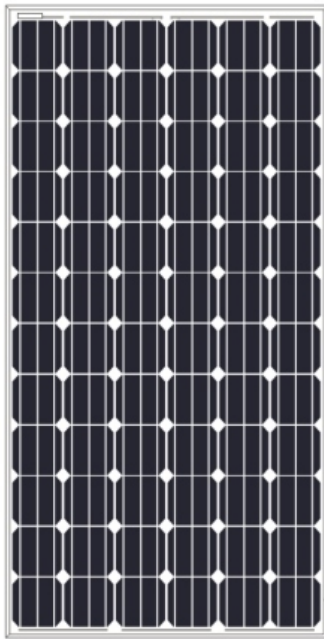

High Quality and Reliable Modules Due to Thorough Design and Stringent Quality Control

- Withstand up to 5400 Pa snow load and 2400 Pa wind load
- 1000V DC
- Three times of EL inspection on every cell and module for defect free
- Type 1 fire-rating per UL 1703 edition 3
- High salt and ammonia resistance certified by TUV Rheinland
- 0~+5 W guaranteed positive tolerance on nameplate power output

Warranty

- 12- year product warranty
- 25-year linear power output warranty

Comprehensive Certificates for Products and Management

- UL 1703, IEC 61215, IEC 61730, CEC listed, MCS and CE
- ISO 9001 for Quality Management Systems
- ISO 14001 for Environmental Management Systems

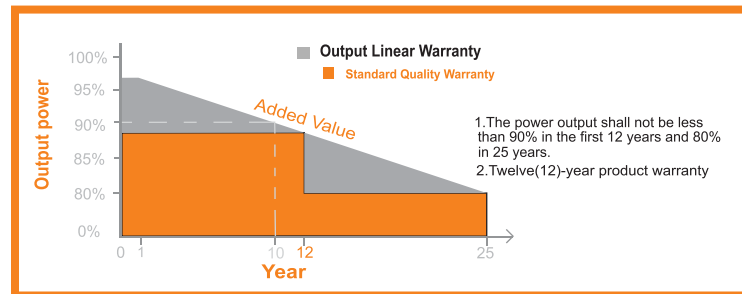

Electrical Characteristics STC

	BVM6612M-300	BVM6612M-305	BVM6612M-310	BVM6612M-315	BVM6612M-320
Maximum Power(Pmax)	300W	305W	310W	315W	320W
Maximum Power Current(Imp)	8.17A	8.31A	8.33A	8.38A	8.46A
Maximum Power Voltage(Vmp)	36.7V	36.7V	37.2V	37.60V	37.80V
Short Circuit Current (Isc)	8.83A	8.98A	9.00A	9.05A	9.08A
Open Circuit Voltage (Voc)	45.5V	45.5V	46.1V	46.1V	46.3V
Module Efficiency	15.5%	15.7%	16.0%	16.23%	16.49%
Power Tolerance	0~+5W	0~+5W	0~+5W	0~+5W	0~+5W

STC:AM1.5,Irradiance 1000W/ m² , 25°C

Electrical Characteristics NOCT

	BVM6612M-300	BVM6612M-305	BVM6612M-310	BVM6612M-315	BVM6612M-320
Maximum Power(Pmax)	221W	226W	230W	234W	238W
Maximum Power Current (Imp)	6.34A	6.38A	6.47A	6.54A	6.62A
Maximum Power Voltage (Vmp)	35.0V	35.4V	35.5V	35.8V	35.9V
Short Circuit Current (Isc)	6.96A	7.02A	7.07A	7.10A	7.15A
Open Circuit Voltage (Voc)	42.8V	43.1V	43.6V	43.9V	44.1V

NOCT: AM1.5, Irradiance 800W/m² , 20 °C , Wind speed 1m/s

Packing Information

Pieces per pallet	26
Pallets per container(40HQ)	22
Pieces per container(40HQ)	572
Pallets weight/size	1671.1lb/82.68*44.49*45.28 inch

Maximum Ratings

Operating Temperature	-40 °F~185 °F
Maximum Series Fuse Rating	15A
Maximum System Voltage	1000V DC

I-V Curves at different Irradiances (300W)
Test temperature: 25°C

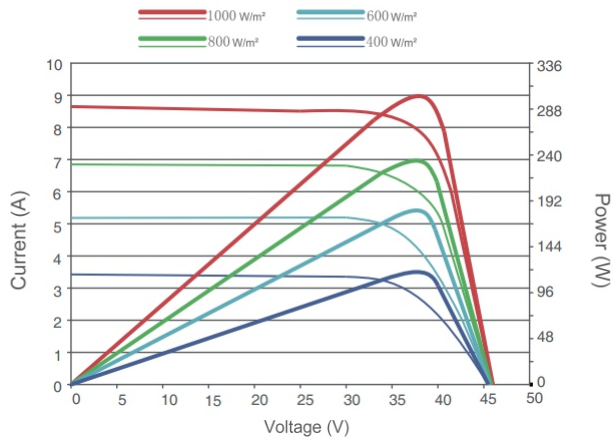

Irradiance: AM1.5, 1000W/m² (300W)

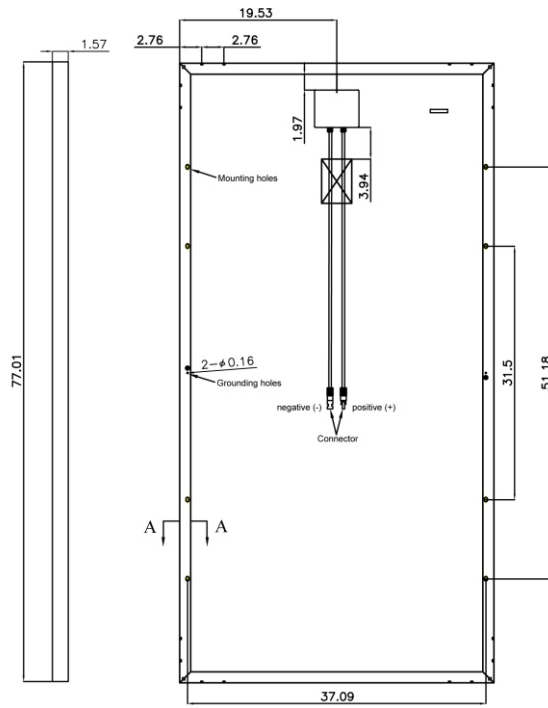
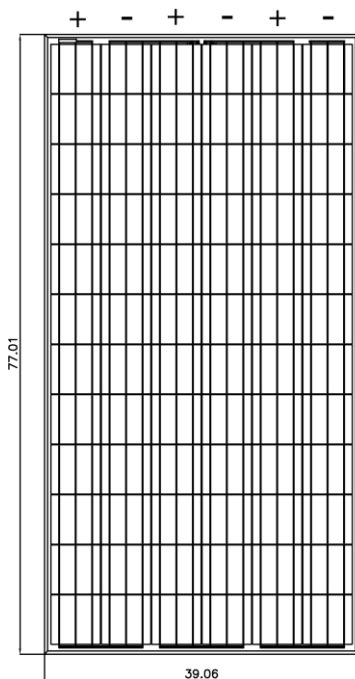
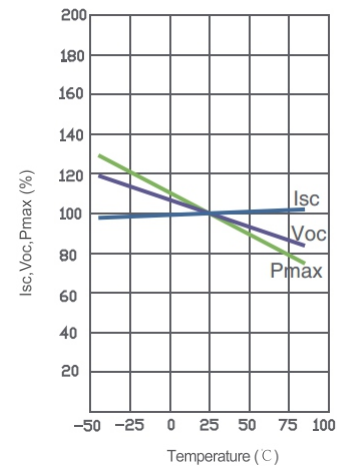

(Unit: Inch)

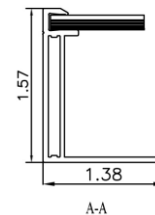

Mechanical Characteristics

Solar Cell	Monocrystalline 6.14x6.14inch, 72(6x12)pcs in series
Glass	High transparency, low iron, tempered glass 4mm(0.16inch)
Frame	Anodized aluminum alloy
Junction Box	IP65/IP67 rated, with 3 bypass diode
Output cable	4 mm² (EU)/12 AWG (US), 41.34inch long
Connector	MC4 compatible
Dimension	77.01x39.06x1.57inch
Weight	58.42lb

Thermal Characteristics

Pmax Temperature Coefficient	-0.44%/K
Voc Temperature Coefficient	-0.35%/K
Isc Temperature Coefficient	+0.04%/K
NOCT	113±3.6° F

Rev. 09252015